

Valid for Item-No.: 650101, 650160, 650161, 650162, 650173, 650180, 650185

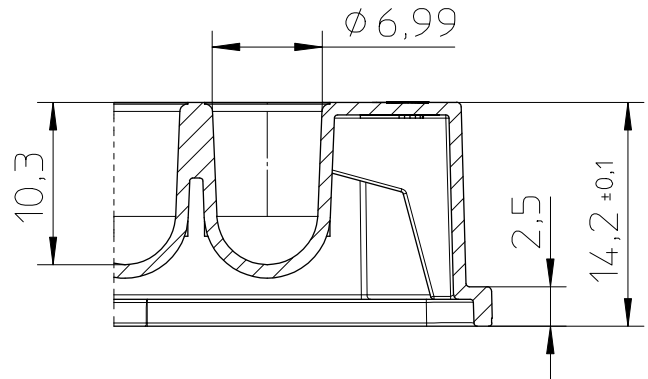

Curvature 0,2

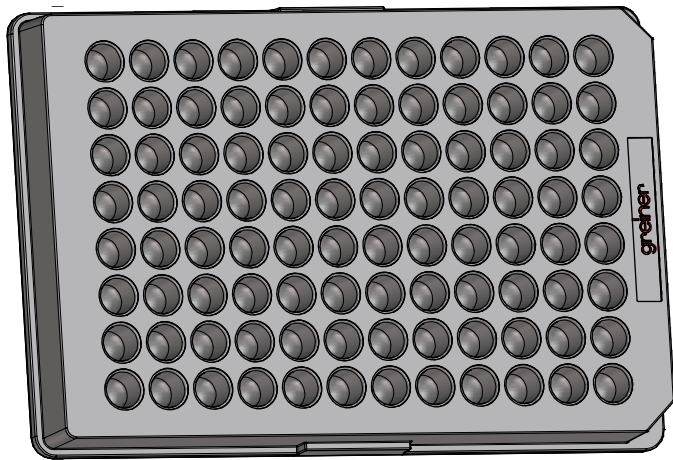
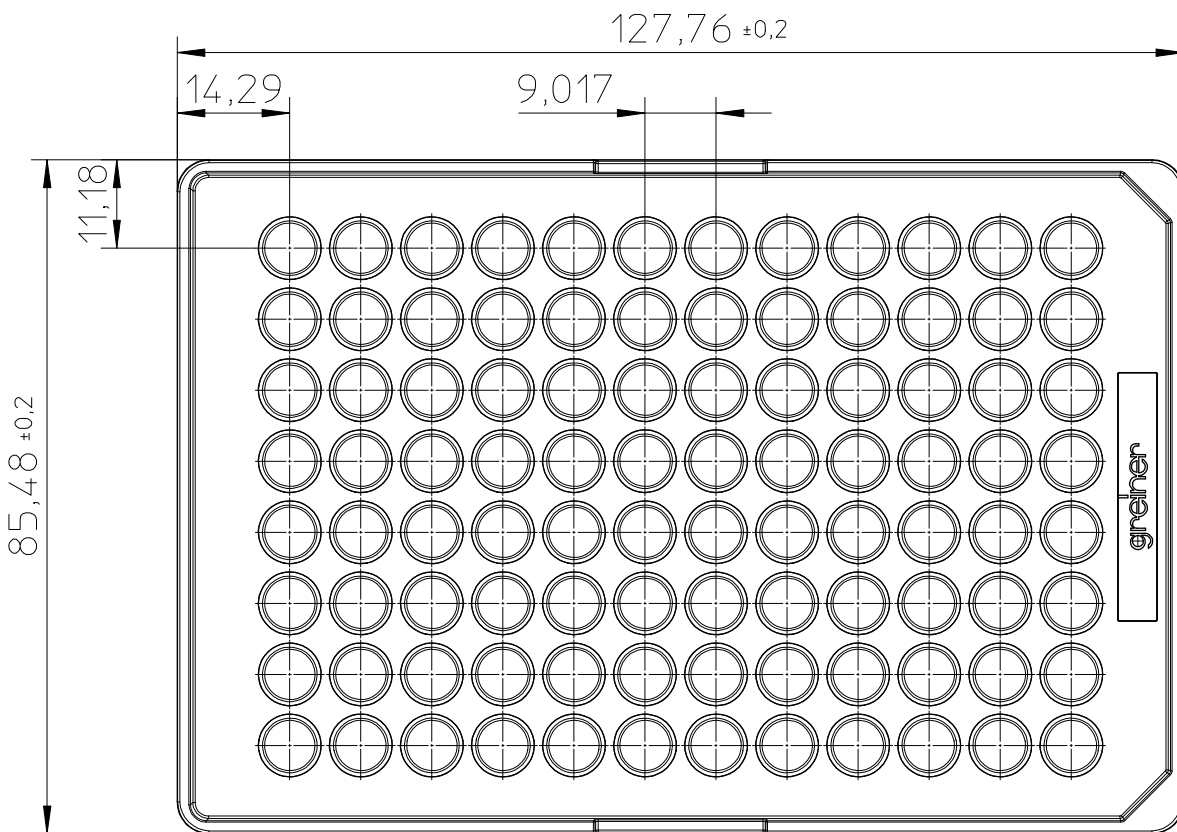
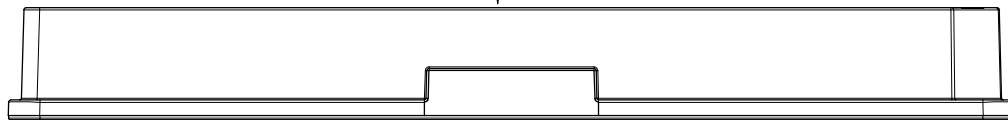

"All dimensions in mm"

Customer drawing subject to change without notice!

Uncontrolled Copy

Prior Issue	Drawn	Approved	Released	CONFIDENTIAL: Information contained in this document or drawing is confidential and proprietary to Greiner Bio-One GmbH. This document may not be reproduced for any reason without written permission from Greiner Bio-One GmbH. All rights of design, invention, and copyright are reserved.
Revision 6	Date 2014/12/08	Date 2023/01/12	Date 2023/01/12	
Date 2022/11/07	Name schwarzj	Name forb	Name kleber	

Valid for Item-No.: 650101, 650160, 650161, 650162, 650173, 650180, 650185

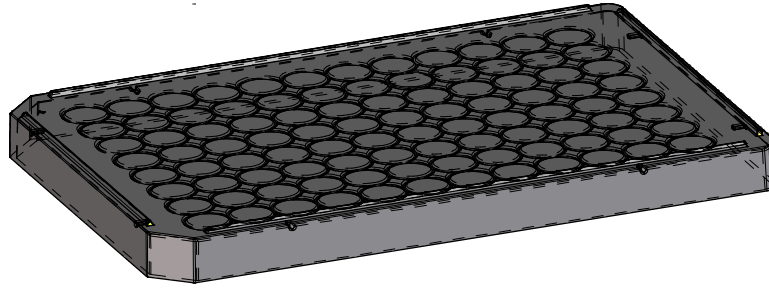

Curvature +0,3  
-0,3

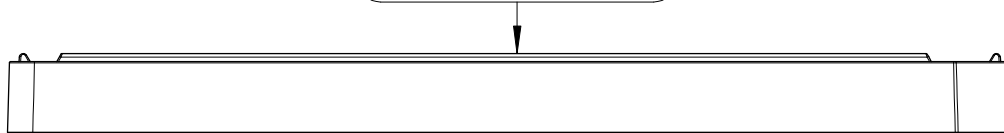

127,5 ±0,2

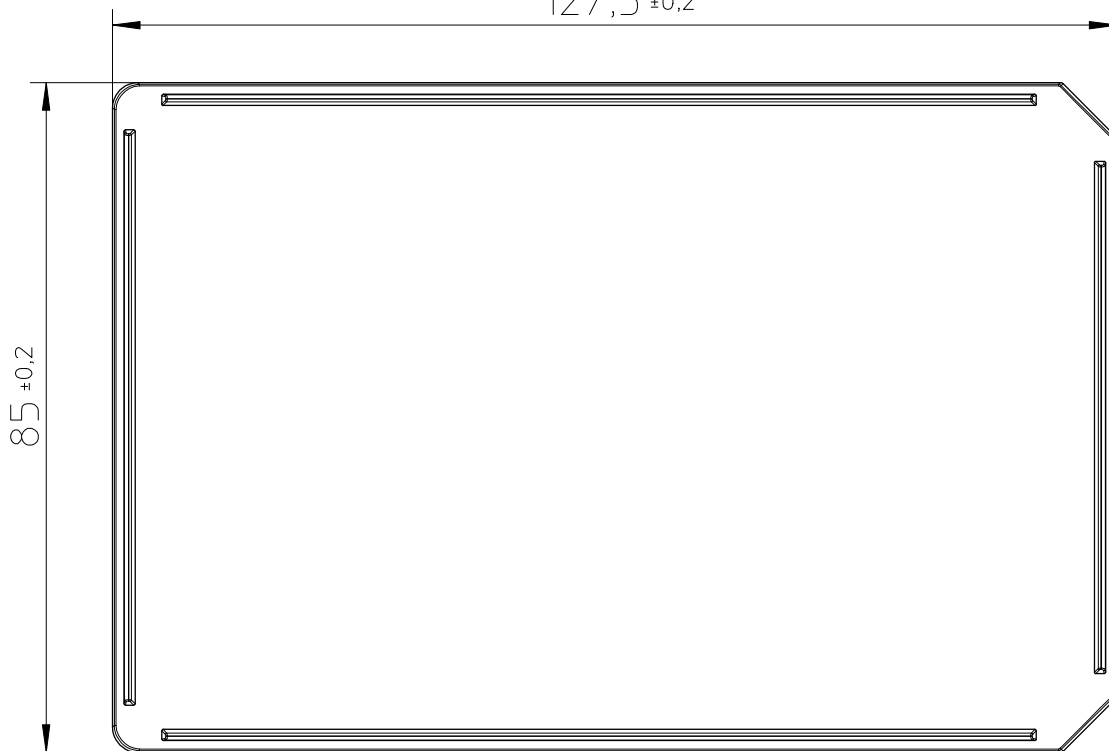

85 ±0,2

Only Part No. 650180 und 650185 with lid

"All dimensions in mm"

Customer drawing subject to change without notice!

Uncontrolled Copy

<b>Prior Issue</b>	<b>Drawn</b>	<b>Approved</b>	<b>Released</b>	CONFIDENTIAL: Information contained in this document or drawing is confidential and proprietary to Greiner Bio-One GmbH. This document may not be reproduced for any reason without written permission from Greiner Bio-One GmbH. All rights of design, invention, and copyright are reserved.
Revision 6	Date 2014/12/08	Date 2023/01/12	Date 2023/01/12	
Date 2022/11/07	Name schwarzj	Name forb	Name kleber	