

Technical Sheet

Rev 02 of 06/02/2020 - Mod. 72-I6-EN

EVO 50 MONO



GENERAL INFORMATION

Disposable containers for special hospital waste disposal

- ▶ **Closing device** Solid lid with sealing glue
- ▶ **Material** Plastic material (100 % polypropylen copolimer)
- ▶ **Colour** Yellow
(Plastic material coloured with masterbatch without heavy metals)
(REACH conformity)
- ▶ **Shape** Truncated pyramid
- ▶ **Lid seal** Contains no latex
- ▶ **External dimensions** 400 x 300 x 560 H mm
(lid closed)
- ▶ **Base dimensions** 340 x 230 mm
- ▶ **Weigth** 1.670 Kg
- ▶ **Max. load** 20 Kg
- ▶ **Volume** 50 L.

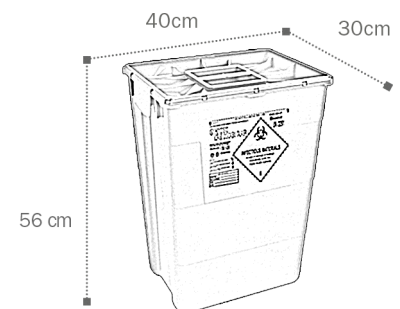

LOGISTIC DATA

- ▶ **Packaging** Bodies stacked onto the pallet together with lids: all shrink wrapped
- ▶ **Pcs. x pall.** 174 pcs.
- ▶ **Pall. Dimensions** 120 x 80 x 227 H cm

CERTIFICATIONS

- ▶ Compliant to ADR - UN Approved
- ▶ Compliant to ISO 23907
- ▶ Compliant to NFX 30-511

INSTRUCTIONS

- ▶ **Temporary closure:** place the solid lid on the body without pressing
- ▶ **Placement of the lid during the use**

Mono lid can be hooked to the body:

On the long side



On the short side

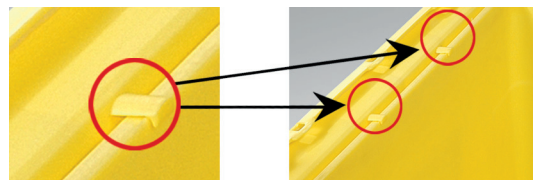

- ▶ **Permanent closure**

1° step:

Push on two opposite corners to firmly hook the lid on the body

2° step:

Push on the other two opposite corners

3° step:

Push on the edge of the short sides and insert the clips

4° step:

Push on the edge of the long sides and insert the clips

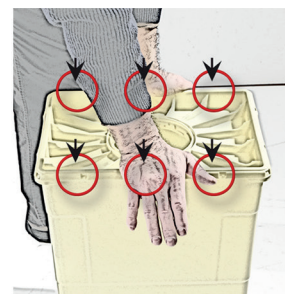
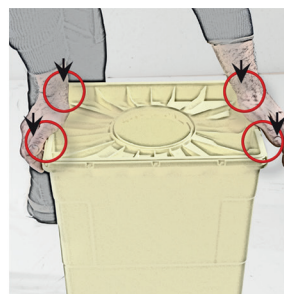

A sound ensures that the clip has been correctly inserted and the clip can be seen in the edge of the lid

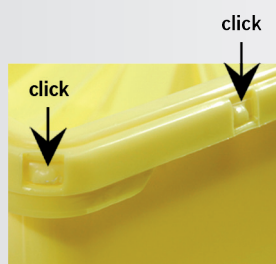

The lid is sealed on the perimeter of the body and the container is watertight thanks to the glue on the lid

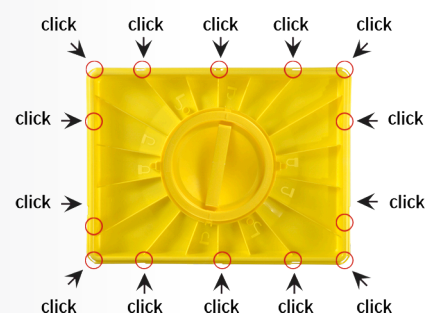

DISPOSAL

- ▶ Once full, the container must be disposed according to current law. If incinerated, the container does not release any toxic emission.

SAFETY INFORMATION

- ▶ Use the container only with its own lid
- ▶ Ensure that the lid is securely fastened
- ▶ Do not exceed the filling level
- ▶ Do not try to open again the sealed/closed container
- ▶ Do not try to recuperate objects inside

TRANSPORT OF THE CONTAINER IN DEFINITIVE CLOSURE

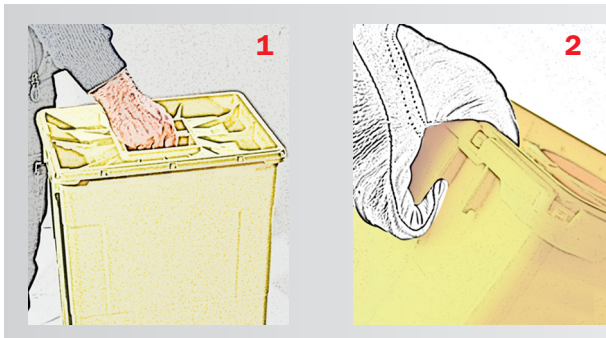

1 With the central handle

2 With the sides handles

ACCESSORIES

- ▶ Possibility to use the container EVO 30 MONO with the trolley Inox four wheels (two with brackets)



ADVANTAGES

- ▶ Handle provided on the solid lid for safe handling
- ▶ Body equipped with two side ergonomic handles (easy grasp even if with gloves)
- ▶ Handles are tested for the double of maximum load
- ▶ Very stable containers, stackable with the best logistic solution to reduce the transport costs as well as the stocks costs
- ▶ Stackable up to 3 m. full load
- ▶ High shock resistance at both low and high temperature
- ▶ High perforation resistance
- ▶ Easy to use
- ▶ Safe permanent closure
- ▶ No noxious gas released during the incineration process